

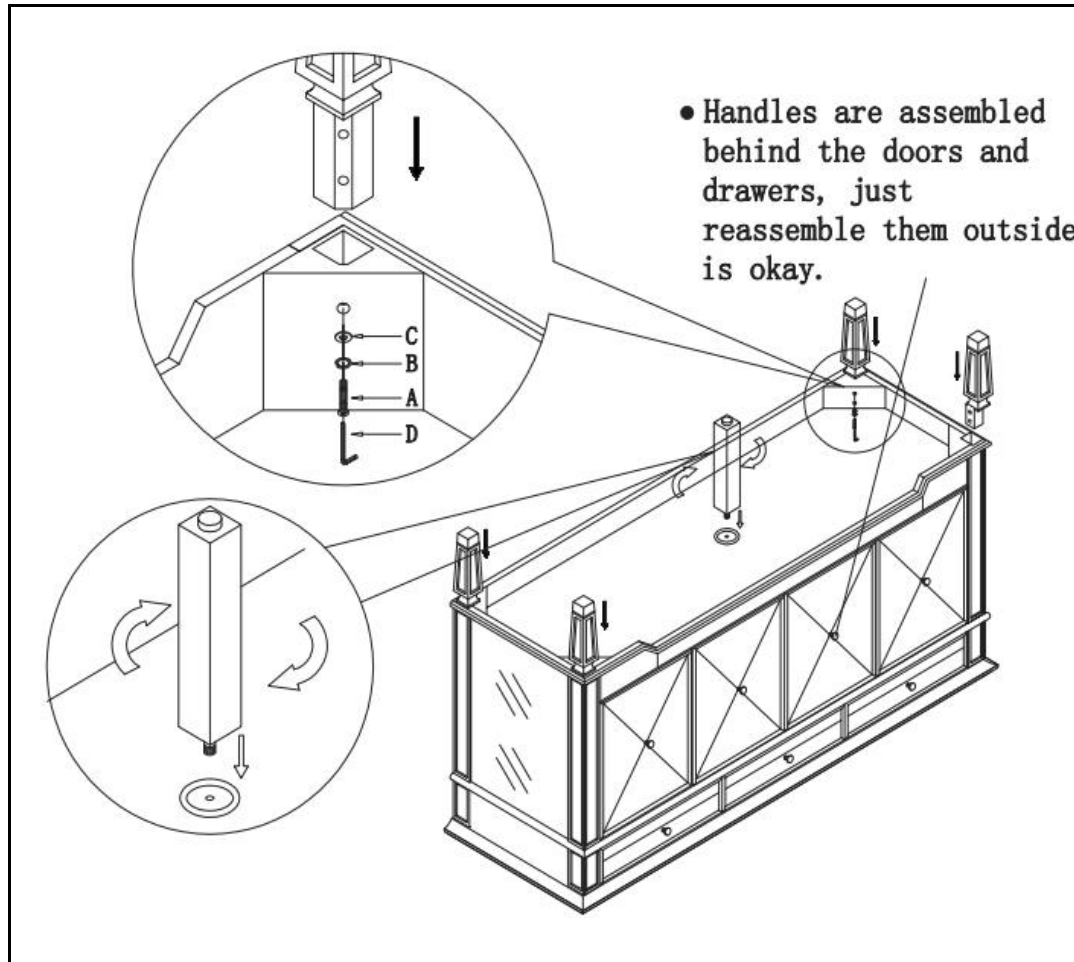





ASSEMBLY INSTRUCTION

ITEM#:VF-1102



HARDWARE LIST

No	FIGURE	DESCRIPTION	Q'TY
A		BIGGER HEX BOLT	8
B		SPRING WASHER	8
C		FLAT WASHER	8
D		ALLEN KEY	1

